



11,000 BTU Portable Air Conditioner
with dehumidifier & Fan
PE4-11R-03
Operating Instructions



Model No. PE4-11R-03

© 2007 Soleus Air International

Thank you for choosing a Soleus Air Portable Air Conditioner. This owner's manual will provide you with valuable information necessary for the proper care and maintenance of your new product. Please take a few moments to thoroughly read the instructions and familiarize yourself with all the operational aspects of your new Soleus Air Portable Air Conditioner.

For your own records, please attach a copy of your sales receipt to this manual. Also, write the store name/location, date purchased, and serial number below:

Store Name: _____

Location: _____

Date Purchased: _____

Serial Number (located on back of unit): _____

IMPORTANT INSTRUCTIONS

Before installing and using your portable air conditioner, please read this owner's manual carefully. Store this manual in a safe place for future reference.

- 1) Always place the unit on a level surface.
- 2) Never use or store gasoline or other flammable vapor or liquid near this unit unless instructed by this manual.
- 3) Maintain at least 10 inches (25 cm) clearance space around this unit. Do not block or cover air inlet or outlet grilles.
- 4) The unit must be connected to a correctly grounded power supply.
- 5) Do not start or stop the unit by inserting or pulling out the power plug.
- 6) Do not use an adapter plug or extension cord.
- 7) Do not use the unit in the immediate surroundings of a bath, a shower or a swimming pool.
- 8) Do not insert anything into the air outlet. Do not obstruct air inlet or outlet grills unless instructed by this manual.
- 9) Do not let children play near this unit.
- 10) Always inspect the cord for signs of damage before use. If the power cord is damaged, it must be replaced by the manufacturer or a qualified service technician.
- 11) When cleaning the unit, always turn the unit off and unplug the power cord.

PACKAGE CONTENTS

Portable Air Conditioner
Exhaust Hoses (1)
Hose Adapters (1)
Window Kit Adapter (1)
Remote Control
AAA Batteries (2)
Window Kit - 3 Sliding Panels (1 single hose panel, 2 extension panels)
Owner's Manual
Wall Cover (1) — the cap covers the whole on the wall or window.

SPECIFICATIONS

- The cooling capacity is measured at an ambient temperature of DB 86 °F, WB 78 °F.
- Noise level is measured at a distance of 3.28 ft away from the front of the unit, when the unit is in cooling mode.
- Power consumption is measured when the fan runs at the highest speed setting.
- These specifications are for reference only. For actual data, please refer to the rating label on the back of the unit.
- If the environment temperature is higher than the max operating temperature or lower than the minimum operating temperature, the air conditioner may not work properly.

MODEL		PE4-11R-03
COOLING CAPACITY		11,000 BTU/H
DEHUMIDIFYING CAPACITY		50 pts per Day
COOLING POWER		1050 W
AIR FLOW VOLUME		260 CFM
POWER SOURCE		115 V~ 60 HZ 8.5AMP
SOUND PRESSURE LEVEL		60 dB(A)
NET WEIGHT		70.5 Lbs
OPERATING TEMPERATURE		60.8°F -95°F
DIMENSIONS	ASSEMBLED	17.7" W × 33.1" H × 14.6" D
	PACKAGE	27.2" W × 34.25" H × 16.7" D
REFRIGERANT		R22

DISCLAIMER

ALL INFORMATION AND THE TECHNICAL SPECIFICATIONS PRESENTED IN THIS USER'S MANUAL ARE THE PRESENTATION OF THE MANUFACTURER. SOLEUS INTERNATIONAL HAS NOT CONDUCTED INDEPENDENT TEST TO THE INFORMATION AND THE SPECIFICATIONS PRESENTED HEREWITHIN.

PRODUCT DIAGRAM

FRONT

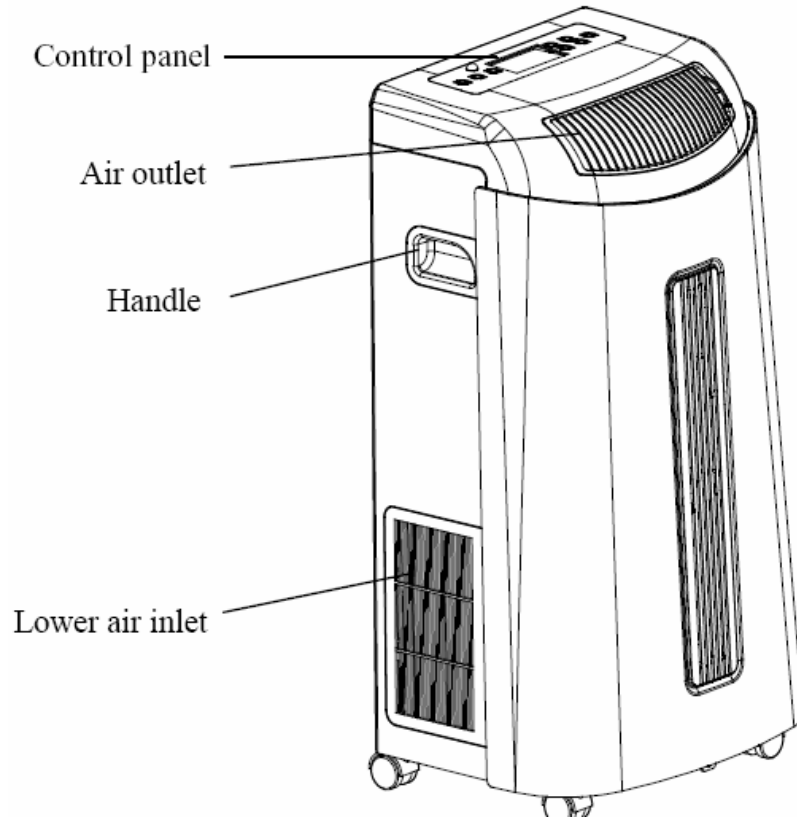

BACK

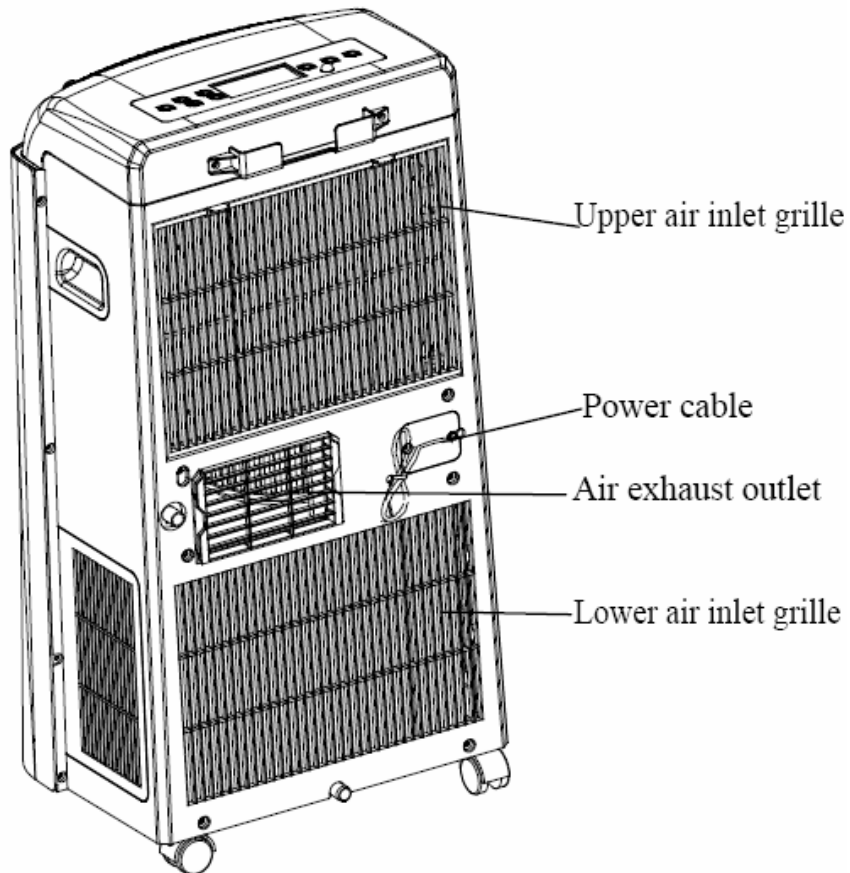

INSTALLATION

SELECTING THE LOCATION

Place the unit on a flat surface in an area where the outlets are not obstructed. Place the unit at least 20" away from all adjacent walls.

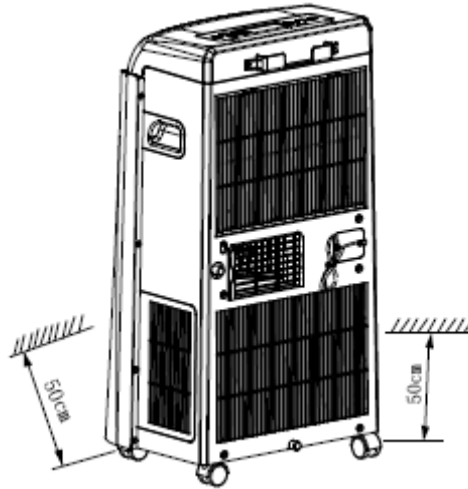

MOUNTING THE EXHAUST HOSE

Slide the square front end of the exhaust duct over the hot air outlet on the back of the unit.

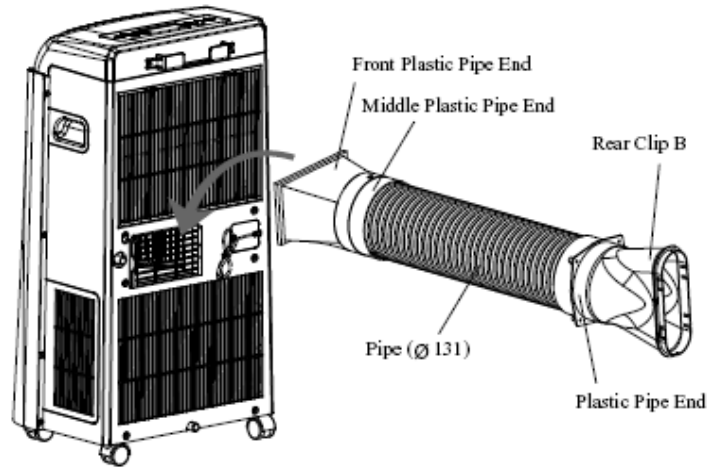

The exhaust hose should be kept as short and straight as possible. Prevent any sharp bends in the exhaust hose, as this will trap hot exhaust air and cause the unit to run less efficiently.

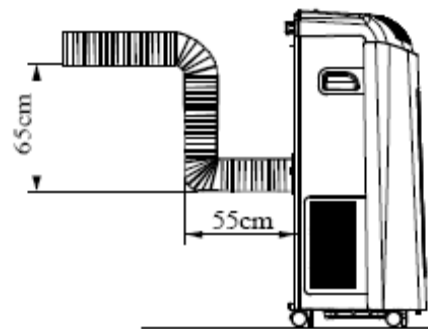

The hot exhaust air can be vented through the wall or out a window. If mounting in the wall, the height of the hole should be 16 to 50 inches (40cm to 130cm).

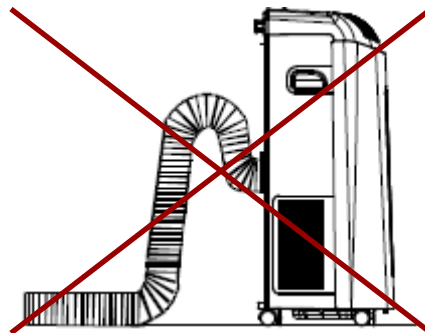

LCDI POWER CORD AND PLUG

This air conditioner is equipped with an LCDI (Leakage Current Detection and Interruption) power cord and plug as required by US National Electric Code 440.65. This cord consists of a length of shielded flexible cord with no termination on the load side and a LCDI attachment plug on the line side.

The LCDI power cord and plug will remove the supply source via electrical disconnect (circuit trip) if the nominal current leakage between the cord shield and either load conductor exceeds a predetermined value. The cord will remain de-energized until the device has been manually reset. This is intended to reduce the risk of a fire in the power cord or combustible materials nearby. The cord shields are not grounded and they must be considered a shock hazards if exposed. The cord shield must not be connected to ground or to any exposed metal.

The test and reset buttons on the LCDI Plug are used to check if the plug is functioning properly. To test:

1. Plug power cord into wall outlet
2. Press TEST Button, circuit should trip, cutting power to the air conditioner
3. Press RESET button for use

If a test is performed and the indicator light remains ON, current leakage has been detected. Do not use the air conditioner or attempt to reset the LCDI Plug. Contact Soleus Air Customer Service for troubleshooting recommendations.

1.3.

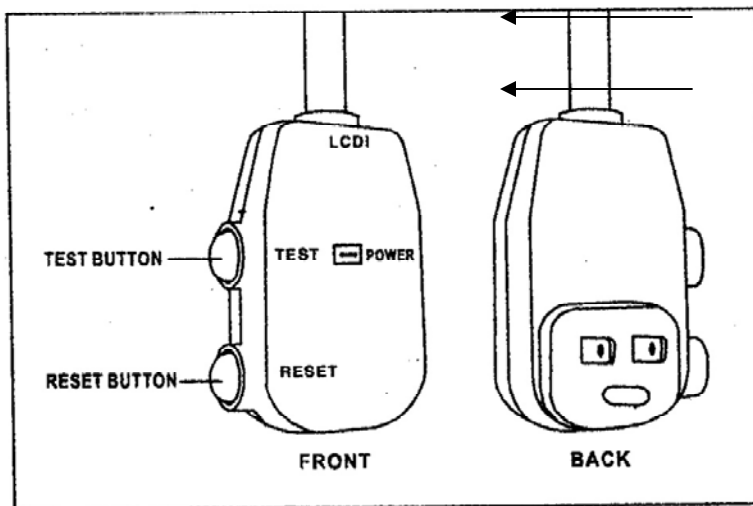

WARNING:

1. DO NOT press the TEST button while the air conditioner is operating.
2. The TEST and RESET buttons should not be used as “ON” and “OFF” switches.
3. The cord and plug are not intended to offer protection to externally connected loads or supply circuits.
4. The cord and plug are intended for indoor use only.

WINDOW KIT INSTALLATION



Innovative products for a cleaner,
more comfortable world.

Installation of the Venting Kit FOR SINGLE HOSE PORTABLE AIR CONDITIONERS

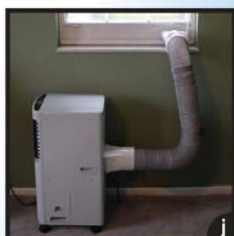
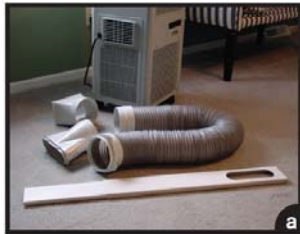

The venting kit must be installed in order for the unit to work correctly in the air conditioning mode. The venting kit should not be used while the unit is heating or fanning.

The window kit has been designed to fit into most vertical and horizontal window openings. The window kit can also be used in a sliding door.

1. Choose a suitable location, near a grounded electrical outlet and a suitable window or door. Remove packaging and locate components. (figure a)
2. Slide the exhaust connector over the discharge opening on the back of the unit. (figure b)
3. Connect the exhaust hose to the exhaust connector, aligning the fitted groove. (figure c)
4. Open the window or door and adjust the length of the window kit to fit the opening. (figure d) If necessary, mark the kit and cut one end down to properly fit the opening. (figures e & f)
5. Attach the window kit adapter to the window kit. (figure g)
6. Place the window kit back into the window and attach the exhaust hose to the window kit adapter. (figures h & i) Close the window tightly. (figure j) Your Portable Air Conditioner is now ready to cool!

NOTE: When using the venting system, keep the exhaust hose as straight as possible. The exhaust hose can be shortened, but it is not recommended to increase the length of the exhaust hose. Do not use an extension cord with your portable air conditioner.

CONTROL PANEL, DISPLAY, & OPERATING INSTRUCTIONS

CONTROL PANEL & LCD DISPLAY

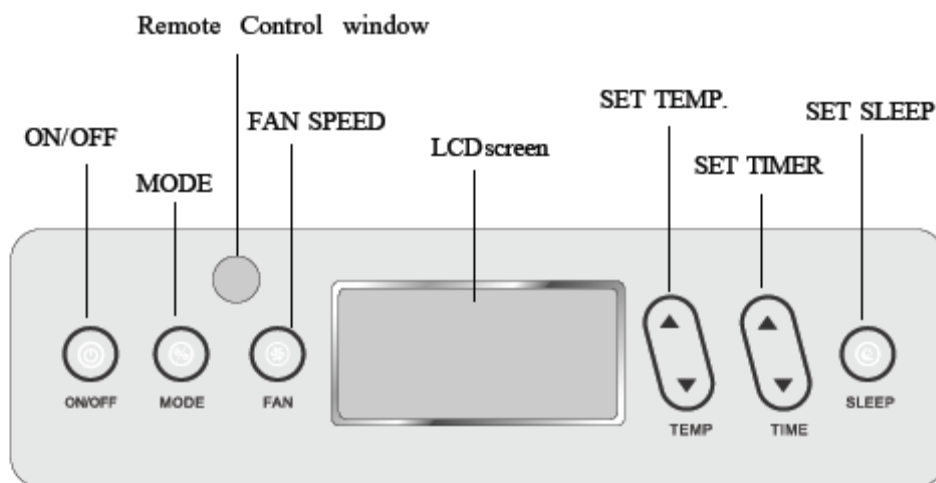

LCD Display

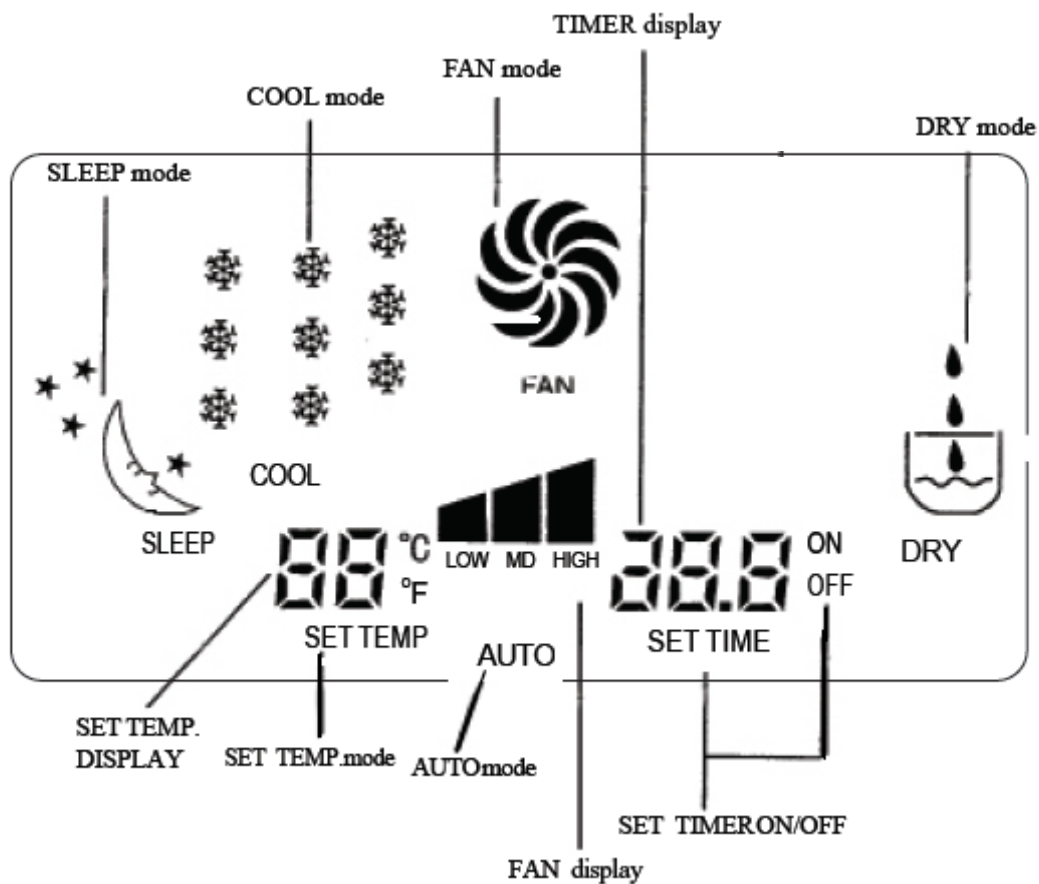

OPERATING INSTRUCTIONS

CONTROL PANEL BUTTONS (Refer to the images on page 9)

- 1) **Power On and Off** - Press the **ON/OFF** button once to manually turn the unit on. Press the **ON/OFF** button once more to turn the unit off.
- 2) **Mode Selection** - Press the **MODE** Button repeatedly to cycle between the different modes: Auto mode, Air Conditioner, Dehumidifier, and Fan.
- 3) **Fan Speed Control** - Press the **FAN SPEED** Button to cycle through the different fan speeds: **High, Medium, and low**. The fan speed can be visually distinguished by the speed of the digital air segments progressing out from the windmill fan image on the Multi-color display. There is an additional **auto** speed setting that is enabled in only heating and cooling modes. This speed is next setting after low when pressing the speed control button. The speeds will cycle through in this order: **Low, Medium, High, Auto**. Each change in speed will be associated with a “beep” sound from the unit.
- 4) **Set Temp**- Select the desired temperature by pressing either ▼ or ▲ on the **SET TEMP** button when using the unit in COOL or HEAT mode.
- 5) **Timer** - To program the timer, press the ▲ or ▼ buttons on the **SET TIMER** button to set the timer. To set the unit to turn on automatically, turn the unit off and select the desired time for the unit to turn on. To set the unit to turn off automatically, turn the unit on then set the timer to turn the unit off at the desired time.
- 6) **Sleep** - When the unit is running, press the **SLEEP** button once to start the sleep operation. Press the **SLEEP** button once more to stop sleep operation.

NOTE: Sleep operation does not work when the unit is in **AUTO** mode

OPERATING THE UNIT USING THE CONTROL PANEL

Air Conditioner Mode

- 1) Install the exhaust hose and window kit properly (see pages 7 & 8).
- 2) Plug the Power Cord into an electrical outlet.
- 3) Turn on the unit by pressing the **ON/OFF** button on the control panel.
- 4) Press the Mode button until the “COOL” icon appears on the LCD display
- 5) Press the ▲ or ▼ buttons until the desired room temperature appears on the control panel display. The temperature ranges from 61 °F - 86 °F (16 °C - 31 °C).
- 6) Select the desired fan speed by pressing the **FAN** button.

NOTE: During hot days, the unit will cool the room most efficiently by setting the temperature at the lowest setting and the fan speed on high. Reducing the length of the exhaust duct, insulating the exhaust hose and window kit, and keeping direct sunlight to a minimum will also improve the cooling efficiency.

NOTE: When the unit is running on cooling mode, the exhaust hoses are required and must be vented outside using the supplied window kit.

Dehumidifier Mode

- 1) Install the exhaust hoses and window kit properly (see pages 7 & 8).
- 2) Plug the Power Cord into an electrical outlet.
- 3) Turn on the unit by pressing the **ON/OFF** Button on the control panel.
- 4) Press the **MODE** button until the “DRY” icon appears on the control panel display.

NOTE: The unit operates at low fan speed during dehumidifier mode. The unit cools room slightly during the dehumidification. Keep the windows and doors closed to aid the effectiveness of the unit in removing the moisture from the room.

NOTE: When the unit is running in dehumidifier mode, the exhaust hoses are required and must be vented outside using the supplied window kit.

NOTE: The unit will not perform in dehumidifier mode when the room temperature is lower than 61 °F .

Fan Mode

- 1) Plug the Power Cord into an electrical outlet.
- 2) Turn on the unit by pressing the **ON/OFF** button on the control panel.
- 3) Press the **MODE** button until the “FAN” icon appears on the control panel display.
- 4) Select the fan speed by pressing the **FAN** button.

NOTE: It is not necessary for the exhaust hoses and window kit to be installed to operate the unit in fan mode.

Auto Mode

- 1) Install the exhaust hoses and window kit properly (see pages 7 & 8).
- 2) Plug the Power Cord into an electrical outlet.
- 3) Turn on the unit by pressing the **ON/OFF** button on the control panel.
- 4) Press the **MODE** button until the “AUTO” icon appears on the control panel display. Select the fan speed by pressing the **FAN** button.

NOTE: During AUTO mode, the unit operates in **Dehumidifier** mode when the room temperature is between 68 °F to 80 °F. And **Air Conditioner** mode when the room temperature is above 80 °F.

Emergency Condensate Holding Tank

When the unit is in cooling mode, unwanted water is extracted from the air. Most of this water is used to cool the unit and make it run more efficiently. When the unit is used in extremely humid environments, water will collect in a water container at the bottom of the unit. When the water container is full, the compressor will stop but the fan will continue to run.

1. Turn the unit off. Do not move the unit when the water container is full.
2. Place the drain pan accessory under the drainage port at the back of the unit.
3. Remove the rubber plug from the drain hole. The condensate water will drain out automatically. When the drain pan is full, replace the rubber plug into the drainage hole to stop the water flow. Empty the drain pan. Repeat until all the water is emptied.
4. If the unit is placed close to a drain, you may attach the drain hose and drain the water into the drain or pan.

Once the water container has been emptied, replace the rubber plug into the drain hole firmly. Do not allow the water to drip continuously into the drain pan, as it might easily overflow.

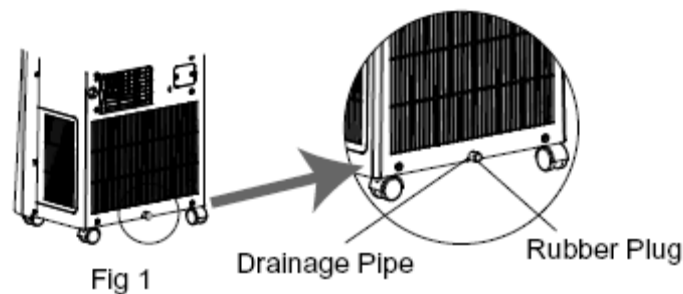

OPERATING THE UNIT USING THE REMOTE CONTROL

REMOTE CONTROL

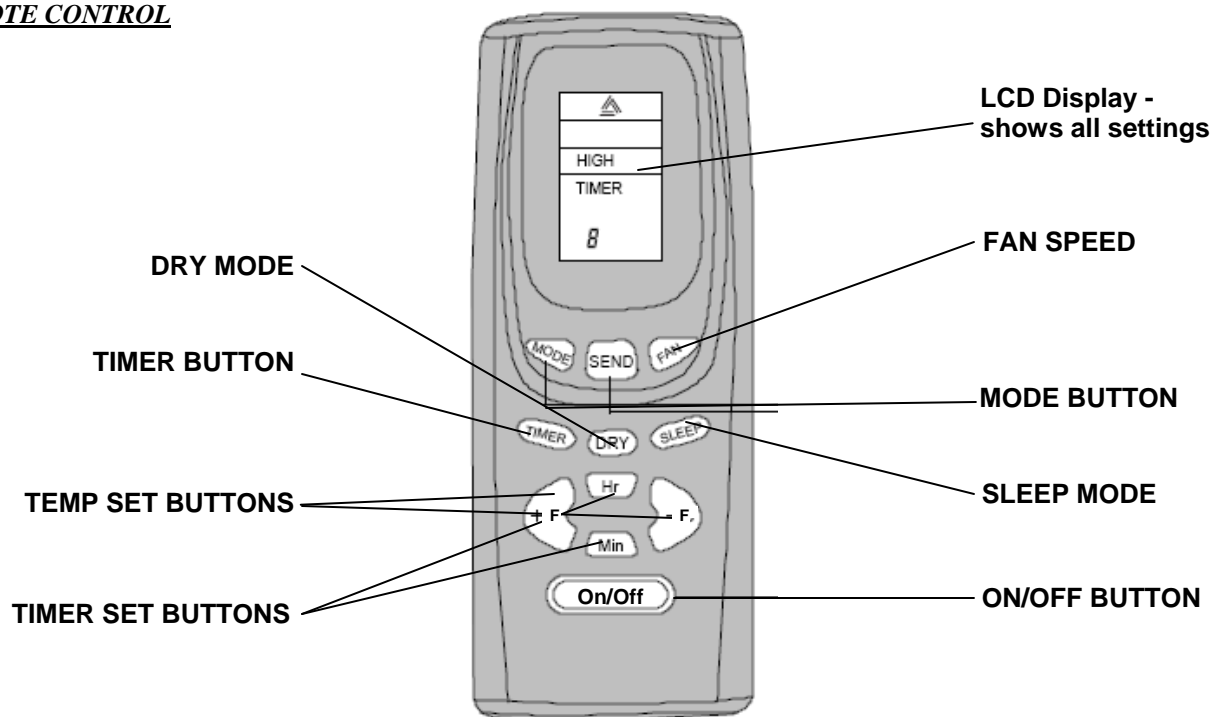

REMOTE CONTROL OPERATING INSTRUCTIONS

- 1) **Power On and Off** - Press the **I/O** button on the remote to turn the unit on or off.
- 2) **Send** - Press this button to transmit the chosen operation. This button must be pressed after every operation change using the remote.
- 3) **Mode Selection** - Press the **MODE** Button repeatedly to cycle between the different modes: Auto, Air Conditioner, Dehumidifier, and Fan only mode. **NOTE: Heat mode can be selected using the remote control, however heat mode is not functional on this unit.**
- 4) **Cooling Mode** - Press the **MODE** button to choose the cooling option. Once cooling mode is selected, choose the desired fan speed and temperature and then press the **SEND** button to transmit the operation.
- 5) **Dry** - Press the **DRY** Button to engage dehumidifier mode. Once **DRY** mode is selected, choose the desired fan speed and temperature, then press the **SEND** button to transmit the operation.
- 6) **Fan Speed** - Press the **FAN** speed button to cycle through low, medium, and high fan speeds.
- 7) **Temperature Setting** - When the unit is in Air Conditioner mode you can select your desired temperature. Press the **+ F** or **- F** buttons to select your desired temperature setting. The temperature on the LCD display will increase or decrease accordingly.

REMOTE CONTROL OPERATING INSTRUCTIONS (CONT.)

- 7) **Sleep Mode** - See "SLEEP MODE" on page 9.
- 8) **Timer** - To program the timer, press the **TIMER** button on the remote control to select the SET TIMER MODE. To program the unit to automatically turn on, make sure the unit is on, then press the **Hr/Min** buttons to select the desired time between 1-18 hours. Once you have chosen the auto-on time, press the **SEND** button to transmit the time. To program the unit to turn off automatically, press the **SLEEP** button on the remote, then press the **Hr/Min** buttons to select the desired time for the unit to turn off.
- 9) After the timer is set to automatically turn on, the unit will shut off and turn on at the set time. Once the **SLEEP** button is pressed, the **SET TIMER** function will be disabled and vice versa.

CARE & MAINTENANCE

Prior to all cleaning and maintenance, please unplug the air conditioner from the outlet.

Cleaning the air filter

1. Press down on the two latches (hooks) on top of the filter and remove the air intake grill from the air conditioner
2. Remove the filter from the air intake grill
3. Wash the filter with a mild soap. You may spray off the unit, or immerse in water.
4. Dry off this filter with a cloth or let it dry in the shade.

NOTE: Do not use hot water when cleaning the filter. It could cause the filter to deform and become unusable.

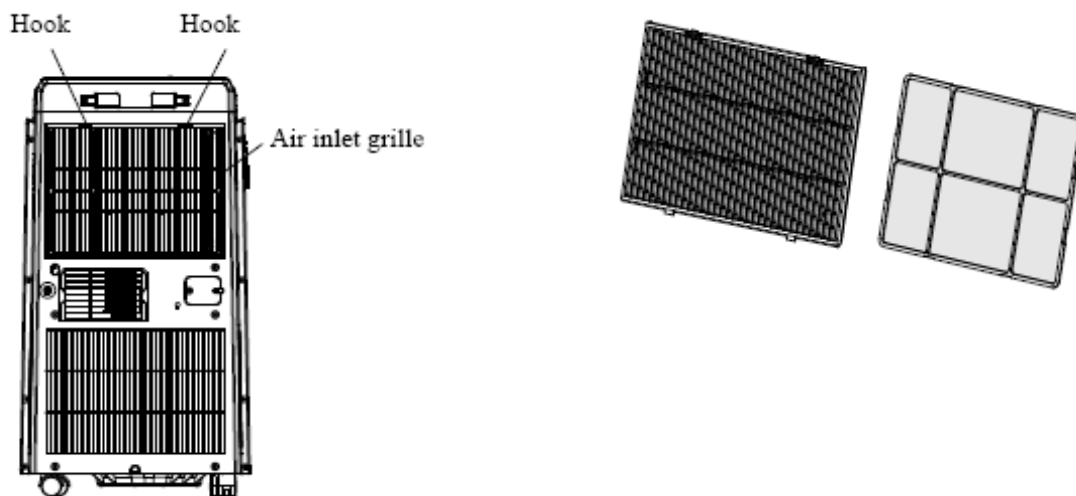

Cleaning the air conditioner

Please use a damp cloth or rag with warm water to wipe down the unit. Do not use gasoline, oil, or household cleaners when cleaning the unit. Before cleaning, make sure the unit is unplugged.



TROUBLESHOOTING

Problem	Possible Cause	Solution
The Air Conditioner Does Not Start	<ul style="list-style-type: none"> • The Power Supply is not Connected to an outlet • The Power plug is not inserted tightly to an outlet • There is a malfunction with the power plug or electrical outlet and/or fuse. 	<ul style="list-style-type: none"> • Insert the power plug tightly in the electrical outlet • Replace the power plug or socket • Replace the fuse.
The LCD display the number for the timer but it does not work	<ul style="list-style-type: none"> • Is the Timer On in operation? 	<ul style="list-style-type: none"> • Cancel the “Set Timer” operation
The unit is set to COOLING mode, but the airflow from the air conditioner is not cool	<ul style="list-style-type: none"> • The room temperature is lower than the set temperature on the unit. • The evaporator needs to defrost 	<ul style="list-style-type: none"> • Set the unit temperature below the room temperature if you wish for the area to be cooler. If not, leave temperature setting alone. • The unit is currently defrosting and will resume normal operation when defrost is complete.
The unit is set to DRY (Dehumidifier) mode and the airflow from the air conditioner is not cool.	<ul style="list-style-type: none"> • The evaporator needs to defrost 	<ul style="list-style-type: none"> • The unit is currently defrosting and will resume normal operation when defrost is complete.
The LCD displays “E1”	<ul style="list-style-type: none"> • There is a current problem with the power supply • There is a problem with the air conditioner 	<ul style="list-style-type: none"> • Turn off the unit and unplug the power cord from the electrical outlet for 10 minutes. After 10 minutes plug the unit back in and try to start the unit. If “E1” is still displayed contact Soleus Air
The LCD displays “H8”	<ul style="list-style-type: none"> • The condensate holding tank 	<ul style="list-style-type: none"> • Empty the condensate holding tank • If “H8” is still displayed the unit may be malfunctioning and you should contact Soleus Air.

WARRANTY

One Year Limited Warranty

Soleus International Inc. warrants the accompanying Soleus Air PE4-11R-03 Portable Air Conditioner to be free of defects in material and workmanship for the applications specified in its operation instruction for a period of ONE (1) year from the date of original retail purchase in the United States.

If the unit exhibits a defect in normal use, Soleus International Inc. will, at its option, either repair or replace it, free of charge within a reasonable time after the unit is returned during the warranty period.

As a condition to any warranty service obligation, the consumer must present this Warranty Certificate along with a copy of the original purchase invoice.

THIS WARRANTY DOES NOT COVER:

- Damage, accidental or otherwise, to the unit while in the possession of a consumer not caused by a defect in material or workmanship.
- Damage caused by consumer misuse, tampering, or failure to follow the care and special handling provisions in the instructions.
- Damage to the finish of the case, or other appearance parts caused by wear.
- Damage caused by repairs or alterations of the unit by anyone other than those authorized by Soleus International Inc.
- Freight and Insurance cost for the warranty service.

ALL WARRANTIES, INCLUDING ANY IMPLIED WARRANTY OF MERCHANTABILITY ARE LIMITED TO ONE-YEAR DURATION OF THIS EXPRESS LIMITED WARRANTY. **SOLEUS INTERNATIONAL INC.** DISCLAIMS ANY LIABILITY FOR CONSEQUENTIAL OR INCIDENTAL DAMAGES AND IN NO EVENT SHALL SOLEUS INTERNATIONAL INC'S LIABILITY EXCEED THE RETAIL VALUE OF THE UNIT FOR BREACH OF ANY WRITTEN OR IMPLIED WARRANTY WITH RESPECT TO THIS UNIT.

This warranty covers only new products purchased from our authorized dealers or retailers. It does not cover used, salvaged, or refurbished products.

As some states do not allow the limitation or exclusion of incidental or consequential damages, or do not allow limitation on implied warranties, the above limitations and exclusions may not apply to you. This warranty gives you specific legal rights, and you may also have other rights that vary from state to state.

For Technical Support and Warranty Service

Please Call (888) 876-5387

Or Write To:

Soleus International Inc.
9451 Telstar Ave.
El Monte, CA 91731 USA
www.soleusair.com